

DLC Display Co., Limited

德爾西顯示器有限公司



MODEL No: DLC0154AZG

TEL: 86-755-86029824

FAX: 86-755-86029827

E-MAIL: sales@dlcdisplay.com

WEB: www.dlcdisplay.com

Record of Revision

Date	Revision No.	Summary
2015-08-07	1.0	Rev 1.0 was issued

1. Scope

This data sheet is to introduce the specification of DLC0154AZG active matrix TFT module. It is composed of a color TFT-LCD panel, driver ICs, FPC and a backlight unit. The 1.54' display area contains 240(RGB) x 240 pixels.

As to basic specification of the driver IC, refer to the IC (ST7789V) specification and datasheet.

2. Application

Digital equipments which need color display, mobile phone, mobile navigator/video systems.

3. General Information

Item	Contents	Unit
Size	1.54	inch
Resolution	240(RGB) x 240	/
Interface	8-bits/9-bit 80 series,	/
Technology type	IPS	/
Pixel pitch	/	mm
Pixel Configuration	R.G.B. Vertical Stripe	
Outline Dimension (W x H x D)	31.52 x 33.72 x1.45	mm
Active Area	27.72 x 27.72	mm
Display Mode	Transmissive	/
Backlight Type	LED	/
Driver IC	ST7789V	/
Weight	TBD	g

4. Outline Drawing

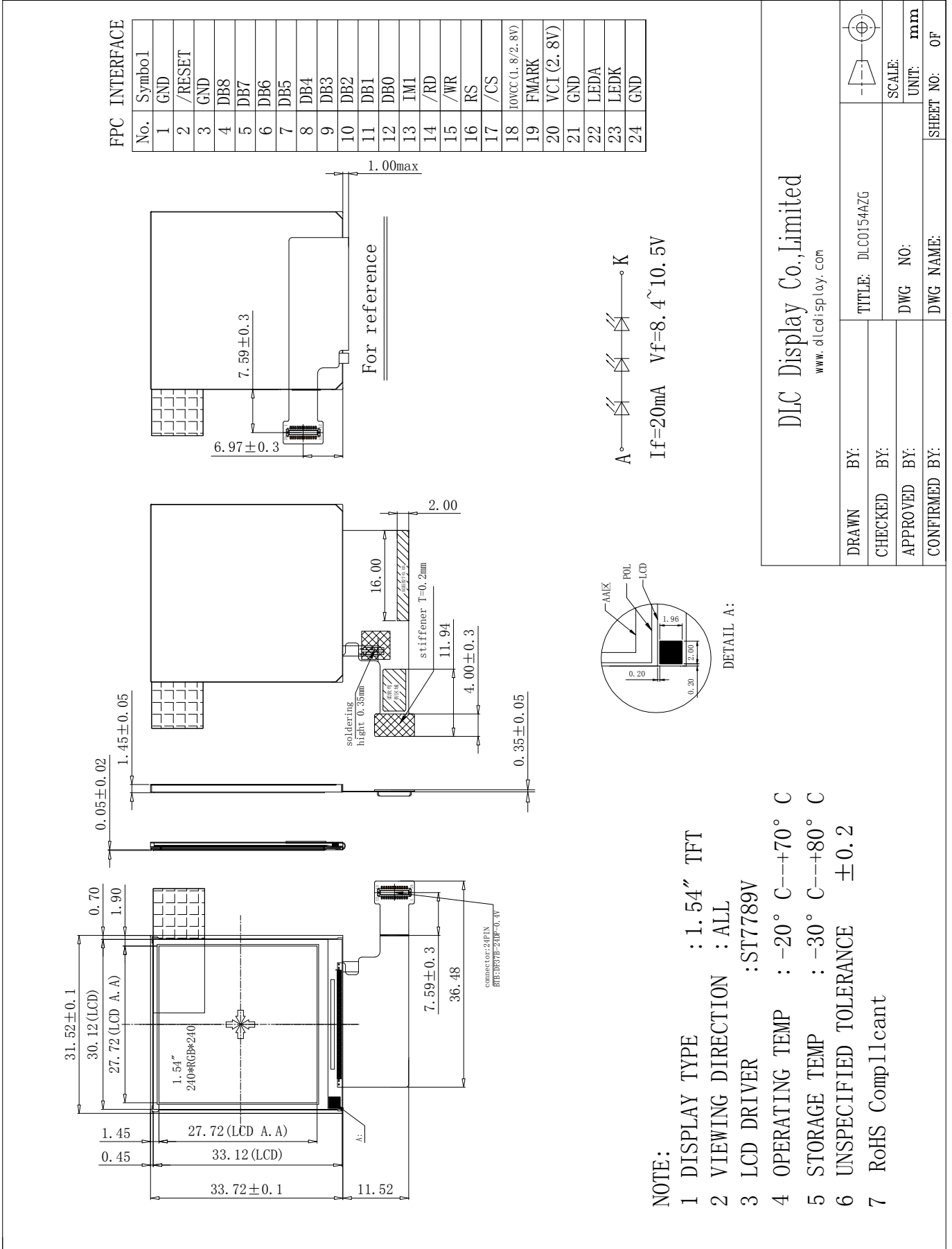

5. Interface signals

NO.	SYMBOL	DISCRIPTION	I/O
1	GND	Ground	P
2	RESET	This signal will reset the device and must be applied to properly initialize the chip. Signal is active low.	I
3	GND	Ground	P
4-12	DB8~DB0	Data Bus	I/O
13	IM1	Select 8bit or 9bit	-
14	RD	Serves as a read signal and MCU read data at the rising edge.	I
15	WR	Serves as a write signal and writes data at the rising edge.	I
16	RS	This pin is used to select “Data or Command” in the parallel interface. When RS= 1, data is selected. When RS = 0’ , command is selected.	I
17	CS	Chip select input pin (“Low” enable).	I
18	IOVCC	Power voltage for logic(1.8V).	P
19	FMARK	Tearing effect output.	-
20	VDD	Supply voltage(2.8V).	P
21	GND	Ground	P
22	LEDA	Anode pin of backlight.	P
23	LEDK	Cathode pin OF backlight.	P
24	GND	Ground	P

6. Absolute maximum Ratings

6.1. Electrical Absolute max. ratings

GND=0V, Ta=25°C

Parameter	Symbol	MIN	MAX	Unit	Remark
Supply voltage	VCC	-0.3	+4.6	V	
Power voltage for logic	IOVCC	-0.3	+4.6	V	
Logic input voltage range	VIN	-0.3	IOVCC+0.3	V	
Logic output voltage range	VOOUT	-0.3	IOVCC+0.3	V	

6.2. Environment Condition

Item	Symbol	MIN	MAX	Unit	Remark
Operating Temperature	TOPR	-20	70	°C	
Storage Temperature	TSTG	-30	80	°C	

7. Electrical Specifications

7.1 Electrical characteristics

Ta=25°C

Parameter	Symbol	MIN	Typ	MAX	Unit	Remark
Supply voltage	VCC	2.5	2.8	3.3		
Power voltage for logic	IOVCC	1.65	1.8	3.3	V	
Supply current for LCM	ILCD	--	8	--	mA	VCC = 2.8V
Supply voltage for back light	VLED	--	9	--	V	
Supply current for back light	ILED	--	15	20	mA	VL = 6.6V
Lifetime of LED	--	--	25,000	--	Hr	

7.2 BLOCK DIAGRAM

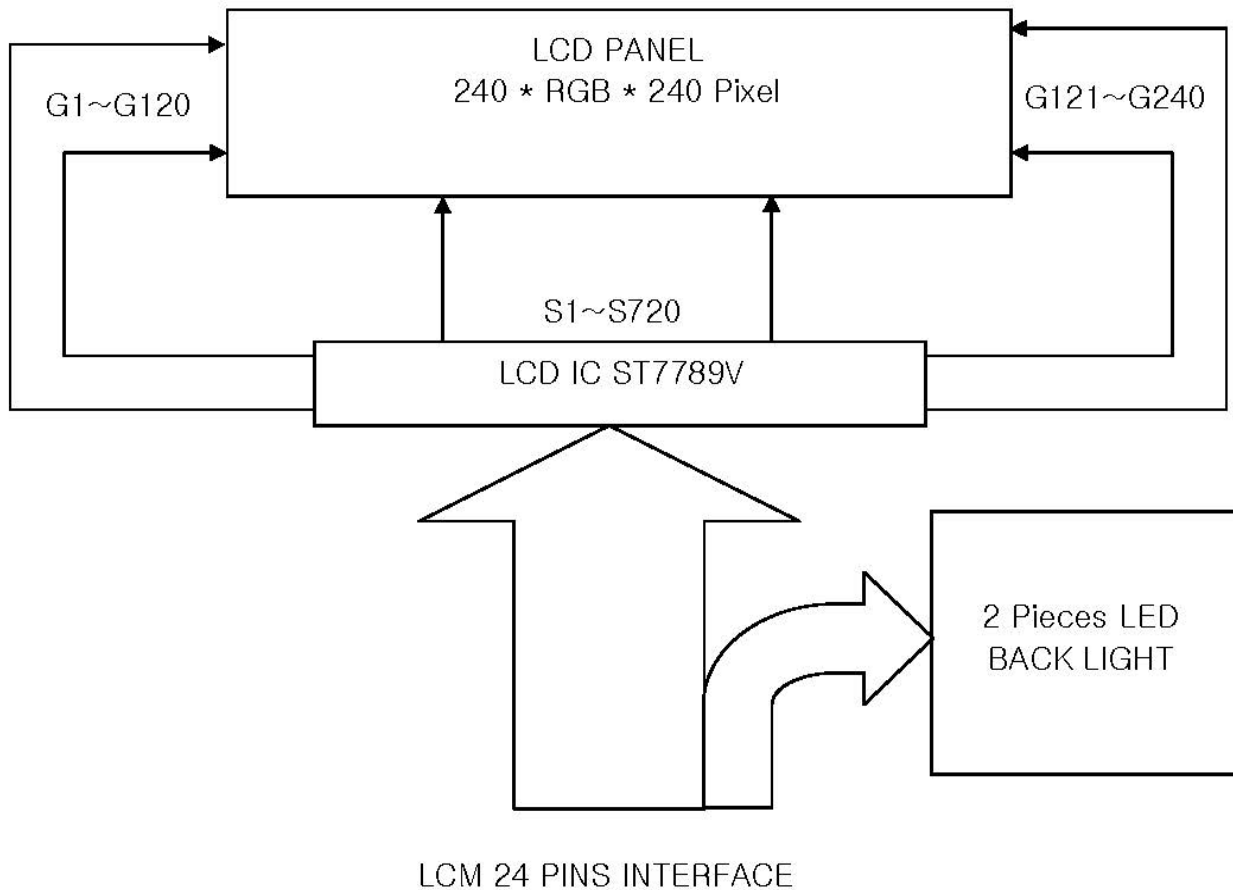

8. Optical Specification

Ta=25°C

Item	Symbol	Condition	Min	Typ.	Max.	Unit	Remark
Contrast Ratio	CR	$\theta=0^\circ$	--	650	--		Note1 Note2
Response Time	Tr/ Tf	25°C	--	--	--	ms	Note1 Note3
View Angles	θT	$CR \geq 10$	--	80	--	Degree	Note 4
	θB		--	80	--		
	θL		--	80	--		
	θR		--	80	--		
Chromaticity	White	x	--	--	--		Note5, Note1
		y	--	--	--		
	Red	x	--	--	--		
		y	--	--	--		
	Green	x	--	--	--		
		y	--	--	--		
	Blue	x	--	--	--		
		y	--	--	--		
NTSC		S	--	--	--	%	Note5
Luminance	L		--	550	--	cd/m ²	Note1 Note6
Uniformity	U		--	80	--	%	Note1 Note7

Note 1: Definition of optical measurement system.

Temperature = 25°C(±3°C); LED back-light: ON, Environment brightness < 150 lx

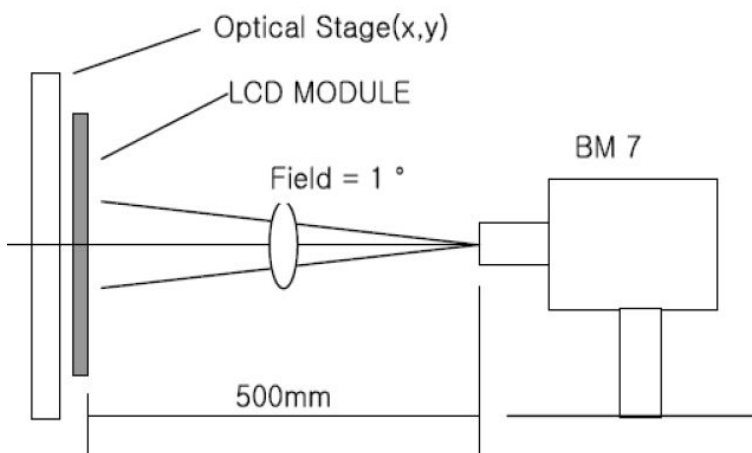

Note 2: Contrast ratio is defined as follow:

$$\text{Contrast Ratio} = \frac{\text{Surface Luminance with all white pixels}}{\text{Surface Luminance with all black pixels}}$$

Note 3: Response time is defined as follow:

Response time is the time required for the display to transition from black to white (Rise Time, T_r) and from white to black (Decay Time, T_f).

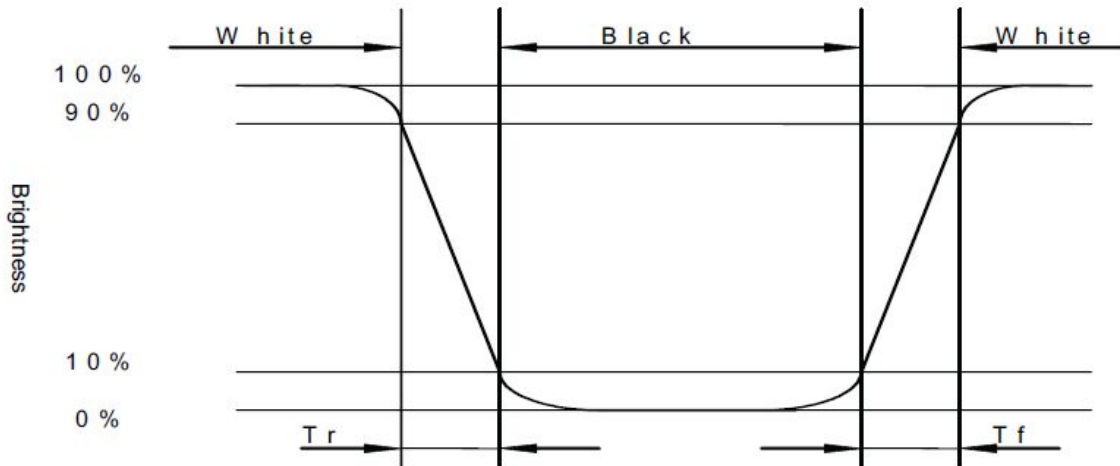

Note 4: Viewing angle range is defined as follow:

Viewing angle is measured at the center point of the LCD.

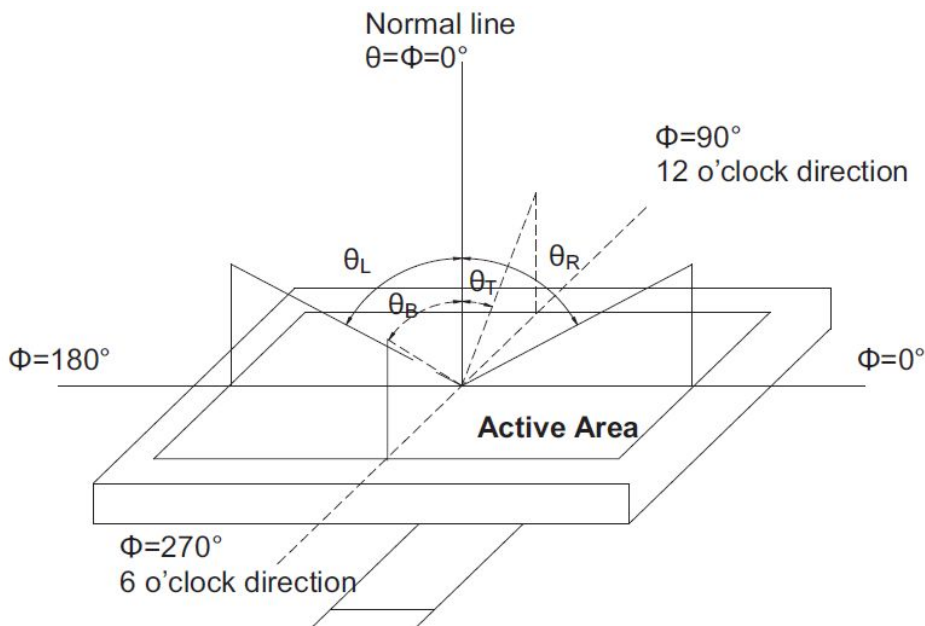

Note 5: Color chromaticity is defined as follow: (CIE1931)

Color coordinates measured at center point of LCD.

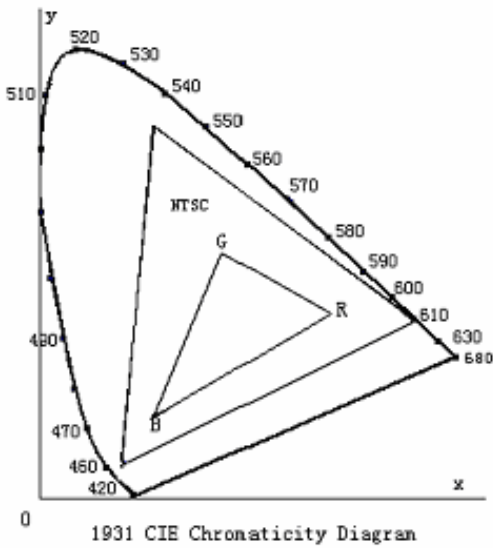

$$S = \frac{\text{area of RGB triangle}}{\text{area of NTSC triangle}} \times 100\%$$

Note 6: Luminance is defined as follow:

Luminance is defined as the brightness of all pixels “White” at the center of display area on optimum contrast.

Note 7: Luminance Uniformity is defined as follow:

Active area is divided into 9 measuring areas (Refer Fig. 2). Every measuring point is placed at the center of each measuring area.

$$\text{Uniformity (U)} = \frac{\text{Minimum Luminance(brightness) in 9 points}}{\text{Maximum Luminance(brightness) in 9 points}}$$

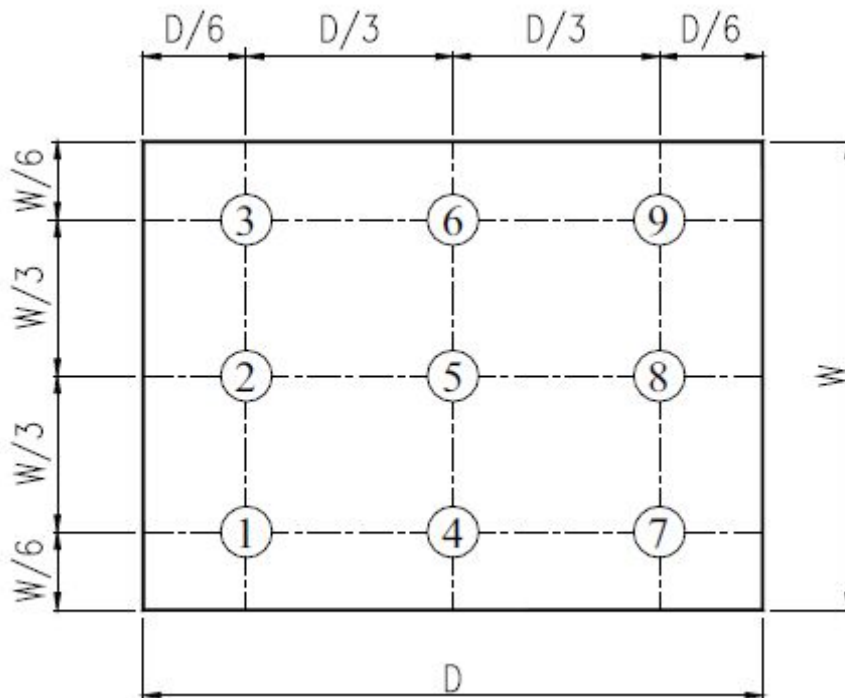

Fig. 2 Definition of uniformity

9. Environmental / Reliability Tests

No	Test Item	Condition	Judgment criteria
1	High Temp Operation	Ts=+80°C, 120hrs	Per table in below
2	Low Temp Operation	Ta=-30°C, 120hrs	Per table in below
3	High Temp Storage	Ta=+70°C, 120hrs	Per table in below
4	Low Temp Storage	Ta=-20°C, 120hrs	Per table in below
5	High Temp & High Humidity Storage	Ta=+40°C, 90% RH 120 hours	Per table in below (polarizer discoloration is excluded)
6	Thermal Shock (Non-operation)	-30°C 30 min~+80°C 30 min, Change time:5min, 10 Cycles	Per table in below
7	ESD (Operation)	C=150pF, R=330Ω , 5points/panel Air:±8KV, 5times; Contact:±4KV, 5 times;	Per table in below
8	Vibration (Non-operation)	Frequency range:10~55Hz, Stroke:1.5mm Sweep:10Hz~55Hz~10Hz 2 hours for each direction of X.Y.Z.	Per table in below
9	Shock (Non-operation)	60G 6ms, ±X,±Y,±Z 3times, for each direction	Per table in below
10	Package Drop Test	Height:80 cm, 1 corner, 3 edges, 6 surfaces	Per table in below

INSPECTION	CRITERION(after test)
Appearance	No Crack on the FPC, on the LCD Panel
Alignment of LCD Panel	No Bubbles in the LCD Panel No other Defects of Alignment in Active area
Electrical current	Within device specifications
Function / Display	No Broken Circuit, No Short Circuit or No Black line No Other Defects of Display

10. Precautions for Use of LCD Modules

10.1 Safety

The liquid crystal in the LCD is poisonous. Do not put it in your mouth. If the liquid crystal touches your skin or clothes, wash it off immediately using soap and water.

10.2 Handling

A. The LCD and touch panel is made of plate glass. Do not subject the panel to mechanical shock or to excessive force on its surface.

B. Do not handle the product by holding the flexible pattern portion in order to assure the reliability

C. Transparency is an important factor for the touch panel. Please wear clear finger sacks, gloves and mask to protect the touch panel from finger print or stain and also hold the portion outside the view area when handling the touch panel.

D. Provide a space so that the panel does not come into contact with other components.

E. To protect the product from external force, put a covering lens (acrylic board or similar board) and keep an appropriate gap between them.

F. Transparent electrodes may be disconnected if the panel is used under environmental conditions where dew condensation occurs.

G. Property of semiconductor devices may be affected when they are exposed to light, possibly resulting in IC malfunctions.

H. To prevent such IC malfunctions, your design and mounting layout shall be done in the way that the IC is not exposed to light in actual use.

10.3 Static Electricity

A. Ground soldering iron tips, tools and testers when they are in operation.

B. Ground your body when handling the products.

C. Power on the LCD module before applying the voltage to the input terminals.

D. Do not apply voltage which exceeds the absolute maximum rating.

E. Store the products in an anti-electrostatic bag or container.

10.4 Storage

A. Store the products in a dark place at $+25^{\circ}\text{C} \pm 10^{\circ}\text{C}$ with low humidity (40% RH to 60% RH). Don't expose to sunlight or fluorescent light.

B. Storage in a clean environment, free from dust, active gas, and solvent.

10.5 Cleaning

A. Do not wipe the touch panel with dry cloth, as it may cause scratch.

B. Wipe off the stain on the product by using soft cloth moistened with ethanol. Do not allow ethanol to get in between the upper film and the bottom glass. It may cause peeling issue or defective operation. Do not use any organic solvent or detergent other than ethanol.

10.6 Cautions for installing and assembling

Bezel edge must be positioned in the area between the Active area and View area. The bezel may press the touch screen and cause activation if the edge touches the active area. A gap of approximately 0.5mm is needed between the bezel and the top electrode. It may cause unexpected activation if the gap is too narrow. There is a tolerance of 0.2 to 0.3mm for the outside dimensions of the touch panel and tail. A gap must be made to absorb the tolerance in the case and connector.

