

**DLC Display Co., Limited**

德爾西顯示器有限公司



MODEL No:DLC0390AZG

TEL: 86-755-86029824

FAX: 86-755-86029827

E-MAIL: [sales@dlcdisplay.com](mailto:sales@dlcdisplay.com)

WEB: [www.dlcdisplay.com](http://www.dlcdisplay.com)

### Record of Revision

Date	Revision No.	Summary
2013-08-29	1.0	Rev 1.0 was issued

## 1. Scope

This data sheet is to introduce the specification of DLC0390AZG active matrix TFT module. It is composed of a color TFT-LCD panel, driver ICs and FPC. The 3.9" display area contains 480(RGB) x 128 pixels.

## 2. Application

Digital equipments which need color display, mobile phone, mobile navigator/video systems.

## 3. General Information

Item	Contents	Unit
Size	3.9	inch
Resolution	480(RGB) x 128	/
Interface	RGB	/
Technology type	a-si TFT	/
Pixel pitch	0.198x0.198	mm
Pixel Configuration	R.G.B. Vertical Stripe	
Outline Dimension (W x H x D)	105.5 x 40.64 x 2.95	mm
Active Area	95.04 x 25.34	mm
Display Mode	TM with Normally White	/
Viewing Direction	6 O'clock	/
Backlight Type	LED	/
Driver IC	HX8257A	/

### 4. Outline Drawing

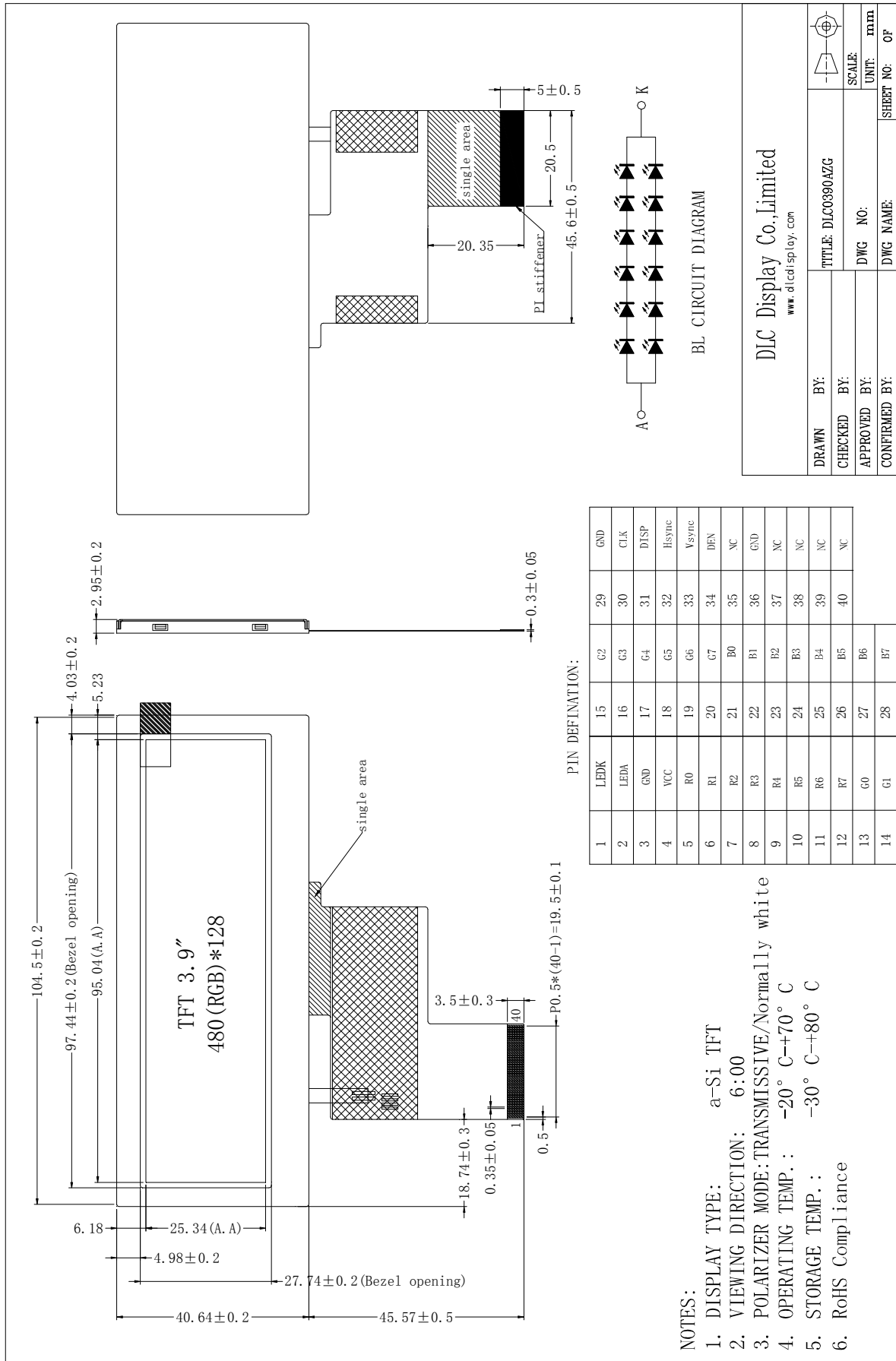

## 5. Interface signals

Pin	Symbol	Description	Remark
1	LEDK	Backlight Cathode	
2	LEDA	Backlight Anode	Note 1
3	GND	Ground	
4	VCC	Power source	
5	R0	Red data signal	
6	R1	Red data signal	
7	R2	Red data signal	
8	R3	Red data signal	
9	R4	Red data signal	
10	R5	Red data signal	
11	R6	Red data signal	
12	R7	Red data signal	
13	G0	Green data signal	
14	G1	Green data signal	
15	G2	Green data signal	
16	G3	Green data signal	
17	G4	Green data signal	
18	G5	Green data signal	
19	G6	Green data signal	
20	G7	Green data signal	
21	B0	Blue data signal	
22	B1	Blue data signal	
23	B2	Blue data signal	
24	B3	Blue data signal	
25	B4	Blue data signal	
26	B5	Blue data signal	
27	B6	Blue data signal	
28	B7	Blue data signal	
29	GND	Ground	
30	CLK	Clock signal to sample each data	
31	DISP	Display on/off signal DISP="H" Display on DISP="L" Display off	
32	Hsync	Horizontal synchronizing signal	
33	Vsync	Vertical synchronizing signal	
34	DEN	Input data enable control.	
35	NC	No connection	
36	GND	Ground	
37~40	NC	No connection	

## 6. Absolute maximum Ratings

### 6.1. Electrical Absolute max. ratings

GND=0V, Ta = 25°C

Parameter	Symbol	MIN	MAX	Unit	Remark
Power Voltage	VCC	-0.3	4.0	V	

### 6.2. Environment Conditions

Item	Symbol	MIN	MAX	Unit	Remark
Operating Temperature	TOPR	-20	70	°C	
Storage Temperature	TSTG	-30	80	°C	

## 7. Electrical Specifications

### 7.1 Electrical characteristics

GND=0V, Ta=25°C

Item	Symbol	MIN	TYP	MAX	Unit	Remark
Power Supply Voltage	VCC	3.0	3.3	3.6	V	
Input Logic Voltage	VIL	0	--	0.3*VCC	V	Note 1
	VIH	0.7*VCC	--	VCC	V	
Output Logic Voltage	VOL	GND	--	0.2*VCC	V	SPDA
	VOH	0.8*VCC	--	VCC	V	

### 7.2 Backlight Characteristics

Item	Symbol	MIN	TYP	MAX	Unit	Remark
Forward Voltage	V <sub>F</sub>	18	19.2	20.4	V	Ta=25 °C, I <sub>F</sub> =20mA/LED
Forward Current	I <sub>F</sub>	--	40	--	mA	Ta=25 °C, I <sub>F</sub> =20mA/LED
Power dissipation	P <sub>D</sub>	--	768	--	mW	
LED Life Time(25 °C)		--	30,000	--	Hr	
Drive method	Constant current					

Note1 : LED life time defined as follows:The final brightness is at 70% of original brightness.

(Required constant current supply I<sub>F</sub> =20mA and  
Environmental condition: 25°C ± 3°C, 60% ± 10%RH)

Note2: Backlighting circuit

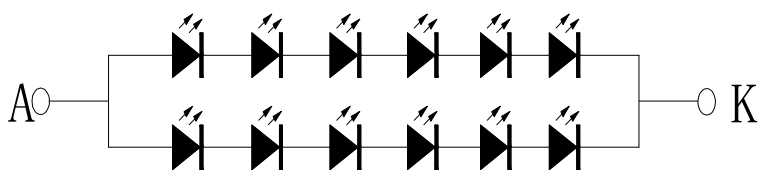

### 7.3 Schematic of LCD module system

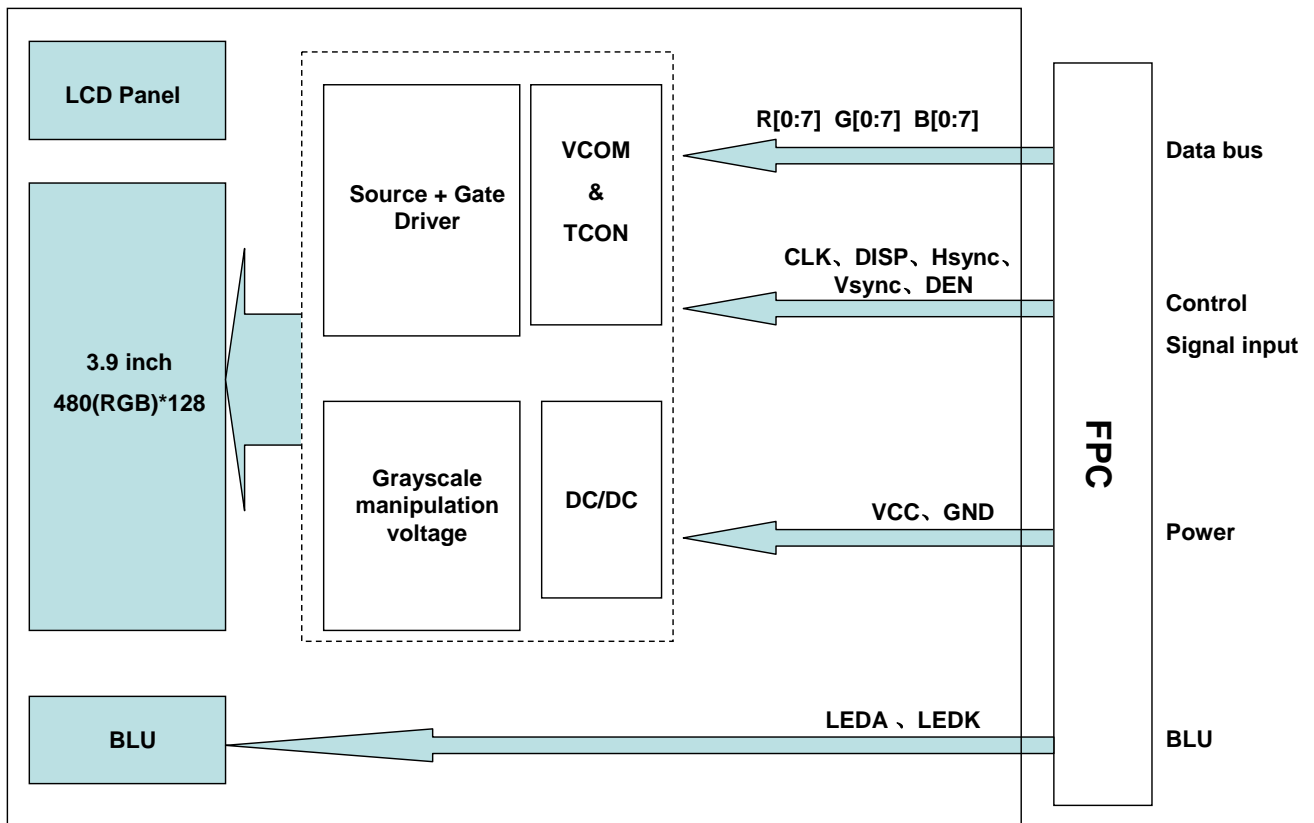

## 8. Command/AC Timing

### 8.1 Parallel RGB 24-bit

Parameter	Symbol	Spec			Unit
		Min.	Typ.	Max.	
Clock cycle	$f_{CLK}^{(1)}$	-	9	15	MHz
Horizontal Signal					
Horizontal cycle	th	525	525	605	CLK
Horizontal display period	thd	480	480	480	CLK
Horizontal front porch	thf	2	2	82	CLK
Horizontal pulse width	thp <sup>(2)</sup>	2	41	41	CLK
Horizontal back porch	thb <sup>(2)</sup>	2	2	41	CLK
Vertical Signal					
Vertical cycle	tv	285	286	399	H <sup>(1)</sup>
Vertical display period	tvd	272	272	272	H <sup>(1)</sup>
Vertical front porch	tvf	1	2	128	H <sup>(1)</sup>
Vertical pulse width	tvp <sup>(2)</sup>	1	10	11	H <sup>(1)</sup>
Vertical back porch	tvb <sup>(2)</sup>	1	2	11	H <sup>(1)</sup>



Note: (1) Unit: CLK=1/f<sub>CLK</sub>, H=th.

Note: (2) It is necessary to keep tvp+tvb=12 and thp+thb=43 in sync mode. DE mode is unnecessary to keep it.

Note: (3) The 1-144 gate lines must be sent black data.

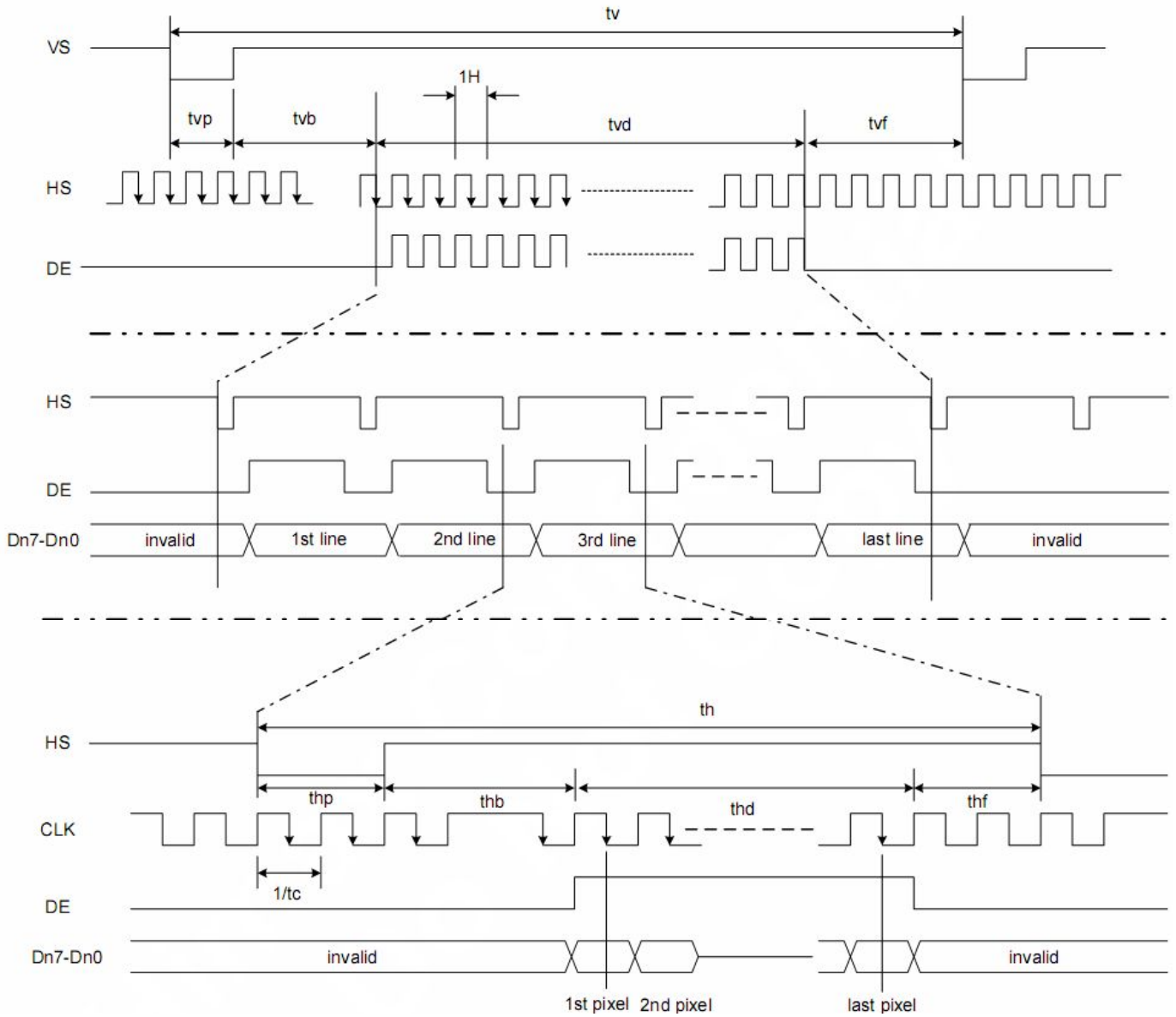

## 8.2 Reset Timing

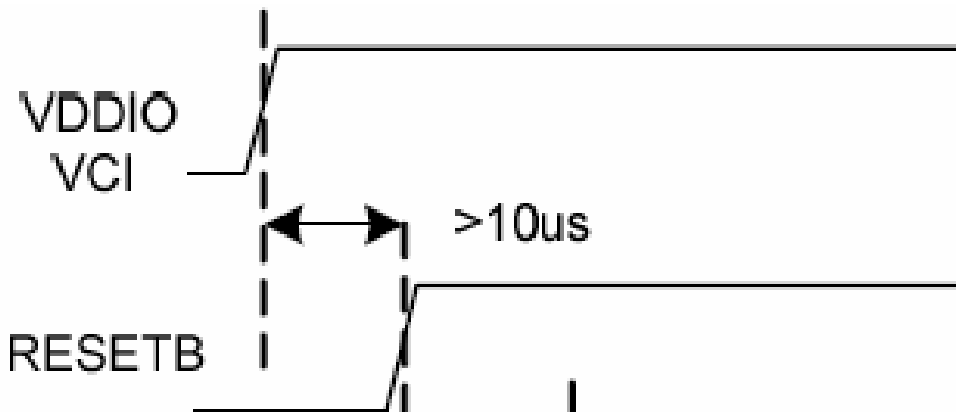

## 9. Optical Specification

Ta=25°C

Item	Symbol	Condition	Min	Typ.	Max.	Unit	Remark
Contrast Ratio	CR	$\theta=0^\circ$	400	500	-		Note1 Note2
Response Time	Ton/ Toff	25°C	-	25	30	ms	Note1 Note3
View Angles	$\theta T$	$CR \geq 10$	60	70	-	Degree	Note 4
	$\theta B$		40	50	-		
	$\theta L$		60	70	-		
	$\theta R$		60	70	-		
Chromaticity	White	Brightness is on	x	0.260	0.310	0.360	Note5, Note1
			y	0.280	0.330	0.380	
	Red		x	0.540	0.590	0.640	
			y	0.300	0.350	0.400	
	Green		x	0.298	0.348	0.398	
			y	0.520	0.570	0.620	
	Blue		x	0.100	0.150	0.200	
			y	0.005	0.100	0.150	
NTSC	S		40	50	-	%	Note5
Luminance	Lv		320	400	-		

Note 1: Definition of optical measurement system.

Temperature = 25°C(±3°C)

LED back-light: ON, Environment brightness < 150 lx

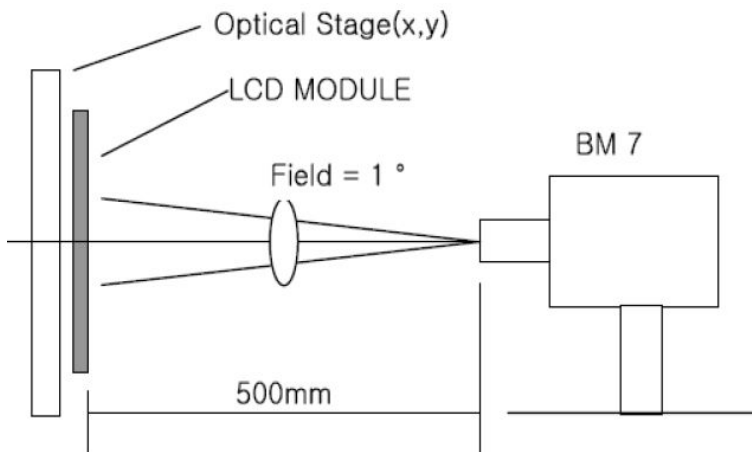

Note 2: Contrast ratio is defined as follow:

$$\text{Contrast Ratio} = \frac{\text{Surface Luminance with all white pixels}}{\text{Surface Luminance with all black pixels}}$$

Note 3: Response time is defined as follow:

Response time is the time required for the display to transition from black to white (Rise Time,  $T_r$ ) and from white to black (Decay Time,  $T_f$ ).

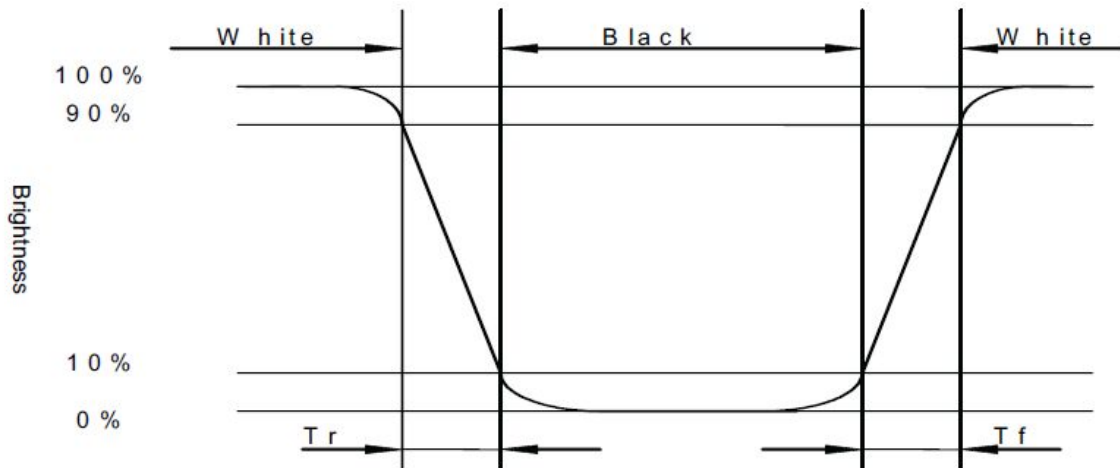

Note 4: Viewing angle range is defined as follow:

Viewing angle is measured at the center point of the LCD.

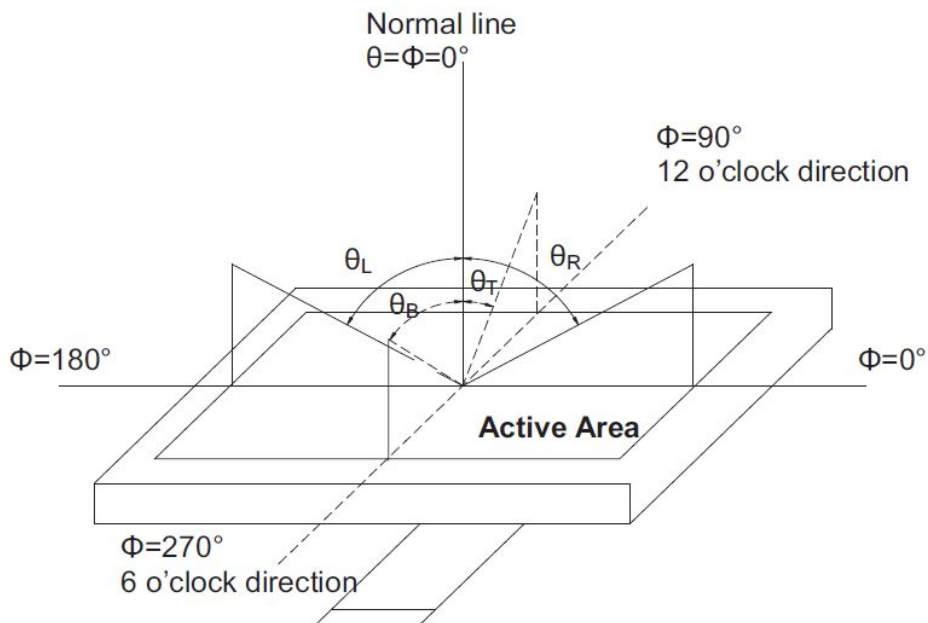

Note 5: Color chromaticity is defined as follow: (CIE1931)

Color coordinates measured at center point of LCD.

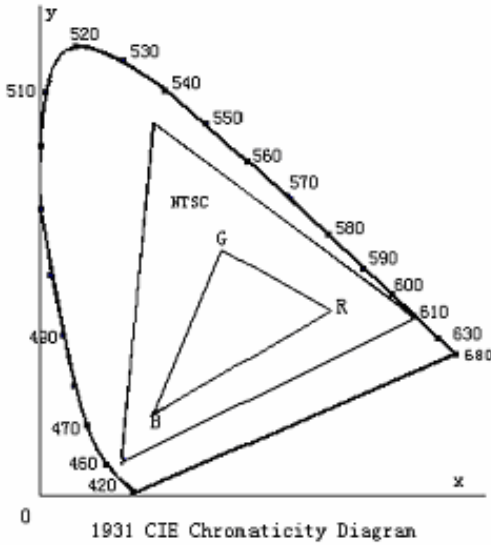

$$S = \frac{\text{area of RGB triangle}}{\text{area of NTSC triangle}} \times 100\%$$

Note 6: Luminance is defined as follow:

Luminance is defined as the brightness of all pixels “White” at the center of display area on optimum contrast.

Note 7: Luminance Uniformity is defined as follow:

Active area is divided into 9 measuring areas (Refer Fig. 2). Every measuring point is placed at the center of each measuring area.

$$\text{Uniformity (U)} = \frac{\text{Minimum Luminance( brightness ) in 9 points}}{\text{Maximum Luminance( brightness ) in 9 points}}$$

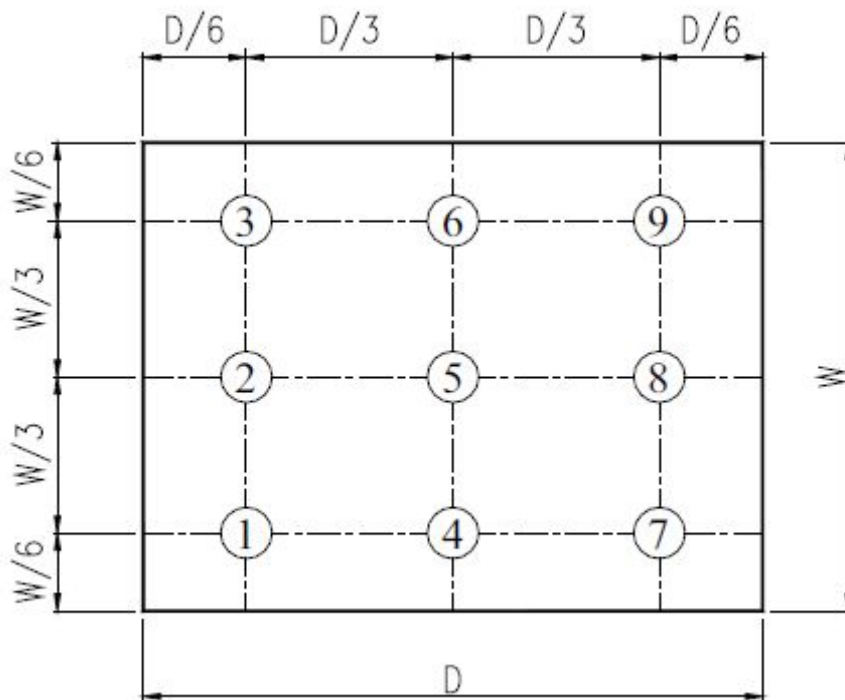

Fig. 2 Definition of uniformity

## 10. Environmental / Reliability Tests

No	Test Item	Condition	Judgment criteria
1	High Temp Operation	Ts=+70°C, 96hrs	Per table in below
2	Low Temp Operation	Ta=-20°C, 96hrs	Per table in below
3	High Temp Storage	Ta=+80°C, 96hrs	Per table in below
4	Low Temp Storage	Ta=-30°C, 96hrs	Per table in below
5	High Temperature & High Humidity Operation	Ta=+50°C, 90%RH, 96hours	Per table in below (polarizer discoloration is excluded)
6	Thermal Shock (Non-operation)	-20°C 30 min~+70°C 30 min, Change time:5min, 100 Cycles	Per table in below
7	ESD (Operation)	C=150pF, R=330Ω, 5points/panel Air:±8KV, 5times; Contact:±4KV, 5 times; (Environment:15°C~35°C, 30%~60%.86Kpa~106Kpa)	Per table in below
8	Vibration (Non-operation)	Frequency range:10~55Hz, Amplitude:1 mm Sweep Time:11 mins Test Period: 6 Cycles for each direction of X,Y,Z	Per table in below
9	Shock (Non-operation)	100G 6ms, ±X,±Y,±Z 3times, for each direction	Per table in below

INSPECTION	CRITERION(after test)
Appearance	No Crack on the FPC, on the LCD Panel
Alignment of LCD Panel	No Bubbles in the LCD Panel No other Defects of Alignment in Active area
Electrical current	Within device specifications
Function / Display	No Broken Circuit, No Short Circuit or No Black line No Other Defects of Display

## 11. Precautions for Use of LCD Modules

### 11.1 Safety

The liquid crystal in the LCD is poisonous. Do not put it in your mouth. If the liquid crystal touches your skin or clothes, wash it off immediately using soap and water.

### 11.2 Handling

- A. The LCD and touch panel is made of plate glass. Do not subject the panel to mechanical shock or to excessive force on its surface.
- B. Do not handle the product by holding the flexible pattern portion in order to assure the reliability
- C. Transparency is an important factor for the touch panel. Please wear clear finger sacks, gloves and mask to protect the touch panel from finger print or stain and also hold the portion outside the view area when handling the touch panel.
- D. Provide a space so that the panel does not come into contact with other components.
- E. To protect the product from external force, put a covering lens (acrylic board or similar board) and keep an appropriate gap between them.
- F. Transparent electrodes may be disconnected if the panel is used under environmental conditions where dew condensation occurs.
- G. Property of semiconductor devices may be affected when they are exposed to light, possibly resulting in IC malfunctions.
- H. To prevent such IC malfunctions, your design and mounting layout shall be done in the way that the IC is not exposed to light in actual use.

### 11.3 Static Electricity

- A. Ground soldering iron tips, tools and testers when they are in operation.
- B. Ground your body when handling the products.
- C. Power on the LCD module before applying the voltage to the input terminals.
- D. Do not apply voltage which exceeds the absolute maximum rating.
- E. Store the products in an anti-electrostatic bag or container.

### 11.4 Storage

- A. Store the products in a dark place at  $+25^{\circ}\text{C} \pm 10^{\circ}\text{C}$  with low humidity (40% RH to 60% RH). Don't expose to sunlight or fluorescent light.
- B. Storage in a clean environment, free from dust, active gas, and solvent.

### 11.5 Cleaning

- A. Do not wipe the touch panel with dry cloth, as it may cause scratch.
- B. Wipe off the stain on the product by using soft cloth moistened with ethanol. Do not allow ethanol to get in between the upper film and the bottom glass. It may cause peeling issue or defective operation. Do not use any organic solvent or detergent other than ethanol.

### 11.6 Cautions for installing and assembling

Bezel edge must be positioned in the area between the Active area and View area. The bezel may press the touch screen and cause activation if the edge touches the active area. A gap of approximately 0.5mm is needed between the bezel and the top electrode. It may cause unexpected activation if the gap is too narrow. There is a tolerance of 0.2 to 0.3mm for the outside dimensions of the touch panel and tail. A gap must be made to absorb the tolerance in the case and connector.

